

DMP 343

Industrial Pressure Transmitter

Without Media Isolation

accuracy according to EN IEC 62828-2:
0,5 % span



Nominal pressure

from 0 ... 10 mbar up to 0 ... 1000 mbar

Product characteristics

- ▶ excellent linearity
- ▶ small thermal effect
- ▶ excellent long term stability



Optional versions

- ▶ IS-version:
Ex ia = intrinsically safe for gases and dusts
- ▶ different electrical and mechanical connections
- ▶ customer specific versions

The pressure transmitter DMP 343 has been especially designed for the measurement of very low gauge pressure and for vacuum applications. Permissible media are gases, pressurized air and non-aggressive low viscos oils.

The DMP 343 features excellent thermal behaviour and outstanding long term stability. A variety of standard output signals as well as mechanical and electrical connections make the DMP 343 covering a wide field of applications.

Preferred areas of use are

-  Plant and Machine Engineering
-  Heating and Air Conditioning



Input pressure range													
Nominal pressure gauge [mbar]	-1000 ... 0	10	16	25	40	60	100	160	250	400	600	1000	
Overpressure [bar]	3	0.2	0.2	0.2	0.5	0.5	1	2	3	3	3	3	
Permissible vacuum [bar]	-1		-0.2			-0.5				-1			
Burst pressure [bar]	5	0.3	0.3	0.3	0.75	0.75	1.5	3	5	5	5	5	

Output signal / Supply	
Standard	2-wire: 4 ... 20 mA / $V_S = 8 \dots 32 V_{DC}$
Option IS-protection	2-wire: 4 ... 20 mA / $V_S = 10 \dots 28 V_{DC}$
Options 3-wire	3-wire: 0 ... 20 mA / $V_S = 14 \dots 30 V_{DC}$ 0 ... 10 V / $V_S = 14 \dots 30 V_{DC}$

Performance	
Accuracy ¹	$\leq \pm 0.5$ % span
Permissible load	current 2-wire: $R_{max} = [(V_S - V_{S min}) / 0.02 A] \Omega$ current 3-wire: $R_{max} = 500 \Omega$ voltage 3-wire: $R_{min} = 10 k\Omega$
Influence effects	supply: 0.05 % span / 10 V load: 0.05 % span / $k\Omega$
Response time	2-wire: ≤ 10 msec 3-wire: ≤ 3 msec
Long term stability	$\leq \pm 0,3$ % span / year at reference conditions, for $P_N < 100$ mbar $\leq \pm 0,1$ % span / year at reference conditions, for $P_N \geq 100$ mbar

¹ accuracy according to EN IEC 62828-2- limit point adjustment (non-linearity, hysteresis, repeatability)

Thermal effects (Offset and Span)				
Nominal pressure P_N [mbar]	-1000 ... 0	≤ 100	≤ 400	> 400
Tolerance band [% span]	$\leq \pm 0.75$	$\leq \pm 1.5$	$\leq \pm 1$	$\leq \pm 0.75$
in compensated range [°C]	-20 ... 85	0 ... 50	0 ... 70	-20 ... 85

Permissible temperatures	
Permissible temperatures	medium: -40 ... 125 °C electronics / environment: -40 ... 85 °C storage: -40 ... 100 °C

Electrical protection	
Short-circuit protection	permanent
Reverse polarity protection	no damage, but also no function
Electromagnetic compatibility	emission and immunity according to EN 61326

Mechanical stability	
Vibration	10 g RMS (25 ... 2000 Hz) according to DIN EN 60068-2-6
Shock	500 g / 1 msec according to DIN EN 60068-2-27

Materials	
Pressure port	stainless steel 1.4404 (316L)
Housing	stainless steel 1.4404 (316L)
Option field housing	stainless steel 1.4301 (304); cable gland M16x 1.5, brass, nickel plated (clamping range 2...8 mm)
Seals (media wetted)	FKM
Sensor	stainless steel 1.4404 (316L), silicon, epoxy or RTV, mineral glass
Media wetted parts	pressure port, seals, sensor

Explosion protection (only for 4 ... 20 mA / 2-wire)	
Approvals DX9-DMP 343	IBExU10ATEX1122 X zone 0: II 1G Ex ia IIC T4 Ga zone 20: II 1D Ex ia IIIC T135°C Da
Certificate BDS 02/2024 X	zone 2: II 3G Ex ec IIC T4 Gc, -20°C < T_a < 70°C
Safety technical maximum values	$U_i = 28 V$, $I_i = 93 mA$, $P_i = 660 mW$, $C_i \approx 0 nF$, $L_i \approx 0 \mu H$, the supply connections have an inner capacity of max. 27 nF opposite the housing
Ambient temperature range	in zone 0: -20 ... 60 °C with p_{atm} 0.8 bar up to 1.1 bar in zone 1 or higher: -40/-20 ... 70 °C
Connecting cables (by factory)	cable capacitance: signal line/shield also signal line/signal line: 160 pF/m cable inductance: signal line/shield also signal line/signal line: 1 $\mu H/m$

Miscellaneous	
Current consumption	signal output current: max. 25 mA signal output voltage: max. 7 mA
Weight	approx. 140 g
Operational life	100 million load cycles
Installation position	any
CE-conformity	EMC Directive: 2014/30/EU
ATEX Directive	2014/34/EU

Wiring diagrams

2-wire-system (current)

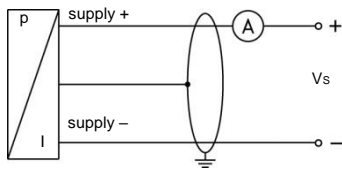

3-wire-system (current / voltage)

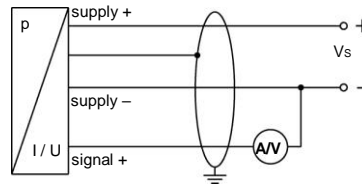

Pin configuration

Electrical connection	ISO 4400	Binder 723 (5-pin)	M12x1 / metal (4-pin)	field housing	cable colours (IEC 60757)
Supply +	1	3	1	IN +	wh (white)
Supply -	2	4	2	IN -	bn (brown)
Signal + (only for 3-wire)	3	1	3	OUT+	gn (green)
Shield	ground pin	5	4		gn/ye (green / yellow)

Electrical connections (dimensions in mm)

standard

option

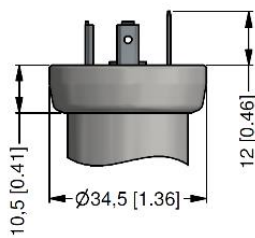

ISO 4400 (IP 65)

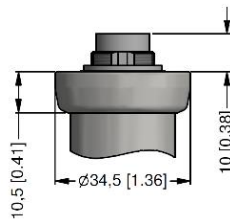

Binder Series 723 5-pin (IP 67)

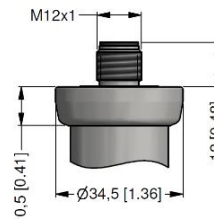

M12x1 4-pin (IP 67)

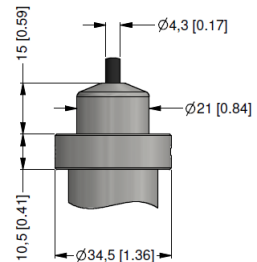

cable gland PG7/cable length specify (IP 67) ²



field housing (IP 67)

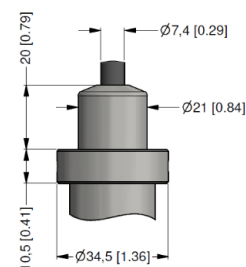

cable outlet, cable with ventilation tube (IP 68) ³

⇒ universal field housing stainless steel 1.4404 (316 L) with cable gland M20x1.5 (ordering code 880) and other versions on request

² standard: 2 m PVC cable without ventilation tube (permissible temperature: -5 ... 70°C)

³ different cable types and lengths available, permissible temperature depends on kind of cable

DMP 343

Industrial Pressure Transmitter

Technical Data

Mechanical connection (dimensions in mm)

standard

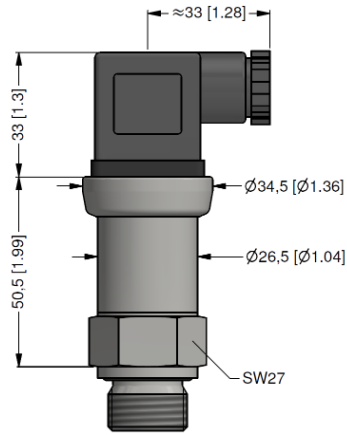

G1/2" DIN 3852
with ISO 4400

option

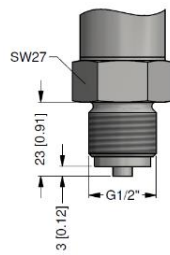

G1/2" EN 837

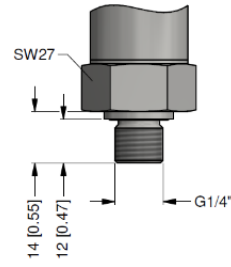

G1/4" DIN 3852

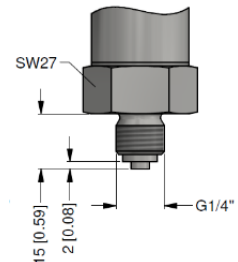

G1/4" EN 837

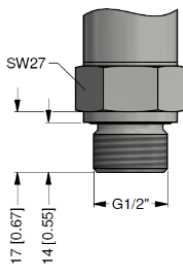

G1/2" DIN 3852

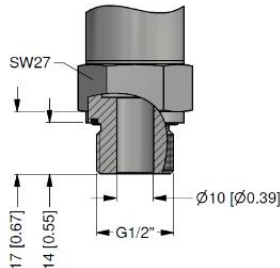

G1/2" open port

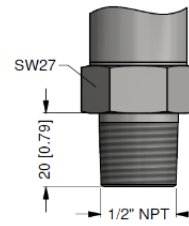

1/2" NPT

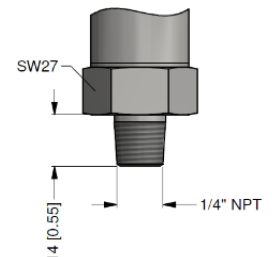

1/4" NPT

⇒ metric threads and others on request

This data sheet contains product specification, properties are not guaranteed. Subject to change without notice.

Ordering code DMP 343

23.08.2024

DMP 343

□	□	□	-	□	□	□	□	-	□	□	-	□	□	□	□	-	□	□	□	□
---	---	---	---	---	---	---	---	---	---	---	---	---	---	---	---	---	---	---	---	---

Pressure																			
Gauge	1	0	0																
Input [mbar]																			
0 ... 6				0	0	6	0												
0 ... 10				0	1	0	0												
0 ... 16				0	1	6	0												
0 ... 20				0	2	0	0												
0 ... 40				0	4	0	0												
0 ... 60				0	6	0	0												
0 ... 100				1	0	0	0												
0 ... 160				1	6	0	0												
0 ... 250				2	5	0	0												
0 ... 400				4	0	0	0												
0 ... 600				6	0	0	0												
0 ... 1000				1	0	0	1												
-1000 ... 0				X	1	0	2												
Customer				9	9	9	9												
Customer underpressure																			
				X	X	X	X												
Output																			
4 ... 20 mA / 2-wire																			1
0 ... 20 mA / 3-wire																			2
0 ... 10 V / 3-wire																			3
0 ... 5 V / 3-wire																			4
Intrinsic safety Ex ia 4 ... 20 mA / 2-wire																			E
Ex ec 4 ... 20 mA / 2-wire (only with connector 105)																			NE
4 ... 20 mA / 3-wire																			7
Customer																			9
Accuracy																			
1 % (P _N ≤ 10 mbar)																			8
0,35 % (standard for P _N > 100 mbar)																			3
0,5 % (P _N > 10 mbar)																			5
1 % including Calibration Certificate (P _N ≤ 10 mbar)																			U
0,5 % including Calibration Certificate (P _N ≥ 10 mbar)																			T
Table of measured values for accuracy 0,5 %																			N
Customer																			9
Electrical connection																			
Connector DIN 43650 (ISO 4400) (IP 65)																			1 0 0
Connector ISO 4400 (IP 65) + silicone seals for Ex ec																			1 0 5
Connector Binder 723 5-pin (IP 67)																			2 0 0
Cable gland PG7 / cable length specify (IP 67)																			4 0 0
+ PVC cable / 1 m																			
Connector Buccaneer (IP 68)																			5 0 0
Connector DIN 43650 (ISO 4400) - potting compound inside (IP 67)																			E 0 0
Cable outlet, cable with ventilation tube (IP 68) ¹																			T R 0
+ PVC cable / 1 m																			
Field housing stainless steel, cable gland M 16 x 1,5 (IP 67)																			8 0 0
Connector M12 x 1, 4-pin (IP 67)																			M 0 0
Connector M12 x 1, 4-pin (IP 67) - metal																			M 1 0
Customer																			9 9 9
Mechanical connection																			
G 1/2" DIN 3852																			1 0 0
G 1/2" EN 837																			2 0 0
G 1/4" DIN 3852																			3 0 0
G 1/4" EN 837																			4 0 0
M 20 x 1,5 DIN 3852																			5 0 0
M 12 x 1 DIN 3852																			6 0 0
M 10 x 1 DIN 3852																			7 0 0
M 20 x 1,5 EN 837																			8 0 0
M 12 x 1,5 DIN 3852																			C 0 0
1/2" NPT																			N 0 0
1/4" NPT																			N 4 0
Customer ²																			9 9 9
Seals																			



Viton (FKM) (standard)	1			
EPDM	3			
NBR	5			
Customer	9			
Special version				
Standard		0	0	0
Adjustable (using trimmers) - ATTENTION must not be used in an EX environment		0	4	1
Customer		9	9	9

0,-...without additional charge

On request...in accordance with the producer

Surcharges for calibration are not subject to any discounts. Subject to change.

This document contains the specification for ordering the product;
detailed technical parameters of the product and its possible variants are given in the data sheet.
BD SENSORS reserves the right to change sensor specifications without further notice.

1 code TR0 = PVC cable, cable with ventilation tube available in different types and lengths; cable not included in the price

2 metric threads and others on request

